

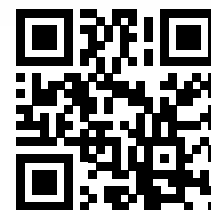





9.6

<http://tiny.cc/9seriesEN>**KOHLER**
ENGINES

 TIPPING LOAD 2600 kg	 ENGINE POWER 57 hp	 SPEED 30 km/h	 FLOW RATE 95 l/min	 LIFT HEIGHT 3,21 m
--	--	---	--	--

Model	9.6
Engine	Kohler 1903 TCR
Power (Iso Gross)	57 HP
Fuel	Diesel
Transmission	Hydrostatic
Drive speed (max.) - 2 speed	15-30 km/h (9.3-18.6 mph)
Aux. hydraulics oil flow	95 l/min (25 GPM)
Max. lifting height	3,21 m (126.4 in)
Tipping load, max ⁽¹⁾	2600 kg (5732 lbs)
Lifting capacity straight ⁽²⁾	2080 kg (4585 lbs)
Lifting capacity fully articulated ⁽³⁾	1600 kg (3527 lbs)
Breakout force / 50 cm	2200 kg (4850 lbs)
Pushing force (c)	1800 kgf (1800 kp)
Specific ground pressure (w/standard tires)	858 kg/m ² (175 lbs/sqft)
Turning radius: inside/outside	1030/2550 mm (40.5/100.4 in)
Standard tires (Tractor profile)	31X15.50-15 (400/50-15)
Weight	2060 kg (4541 lbs)
Product Code	C965005
Price	

Features

- Hi-Flow system
- New Turbo Common Rail Kohler engine (TIER 4 Final)
- 4WD hydrostatic Direct Drive motors, proportional servo control
- DBS (Dynamic Block System)
- Torque divider
- Self-levelling double-H telescopic boom
- 11-functions joystick
- Multi-disk parking brake
- Radial Piston high efficiency and heavy duty wheel motors
- 2 Speed
- Hydraulic oil cooler
- Hydraulic multiconnector
- ROPS-FOPS Level I
- LCD graphic display with programmed service (tachometer, hour meter, fuel gauge, maintenance light, light indicator and other 14 indicators)
- 2 front working light
- Ergonomic full adjustable suspension seat with armrests and safety belt.

⁽¹⁾ Maximum load that can be lifted just off the ground when the machine is straight, with rear weights and boom not extended. Weight of attachment included.

⁽²⁾ Machine straight, with rear weights and boom not extended. Weight of attachment is included. (80% of tipping load)

⁽³⁾ Machine fully articulated, with rear weights and boom not extended. Weight of attachment is included.

9.6 FEATURES AND OPTIONS

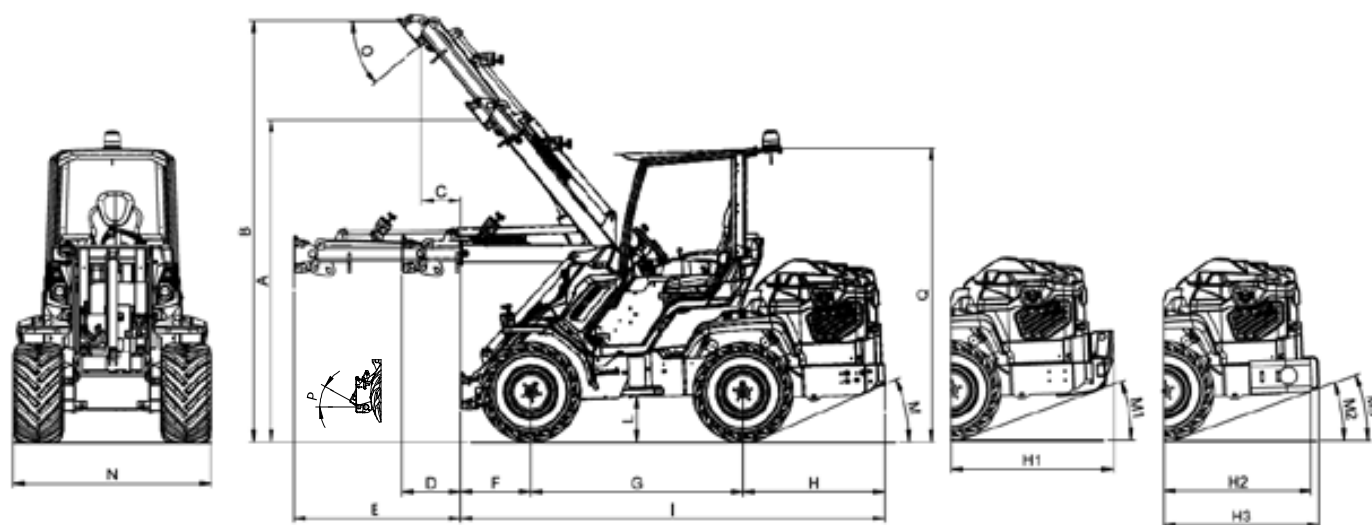

DIMENSIONS (mm / in)

A - Pivot point height (not extended boom)	2530 / 99.6	I - Machine length (without rear weights)	3200 / 126
B - Pivot point height (extended boom)	3210 / 126.4	L - Ground clearance	340 / 13.4
C - Outreach with lifted boom (extended boom)	460 / 18	M - Angle of departure (without rear weights)	24°
D - Outreach with orizontal boom (not extended)	460 / 18	M1 - Angle of departure (with 440 kg rear weights)	19°
E - Outreach with orizontal boom (extended)	1256 / 49.5	M2 - Angle of departure (with 180 kg rear weights - side)	21°
F - Front length	530 / 20.8	M3 - Angle of departure (with 180 kg rear weights - rear)	21°
G - Wheelbase	1600 / 63	N - Max width (with standard tires)	1500 / 59
H - Rear length (without rear weights)	1070 / 42	O - Dump angle	31°
H1 - Rear length (with 440 kg rear weights)	1225 / 48.2	P - Rollback angle	29°
H2 - Rear length (with 180 kg rear weights - side)	1115 / 43.9	Q - Height (with standard tires)	2150 / 84.6
H3 - Rear length (with 180 kg rear weights - rear)	1170 / 46	Q1 - Height with A/C (with standard tires)	2350 / 92.5

Tires size	Width (N)	Height (Q)
31X15.50-15	1500 mm (59 in)	2150 mm (84.6 in)
27X10.50-15	1370 mm (54 in)	2100 mm (83 in)
27X8.50-15	1320 mm (52 in)	2100 mm (83 in)
26X12.00-12	1410 mm (55.5 in)	2090 mm (82.5 in)

9.6 FEATURES AND OPTIONS

Options	Code	Price
Attachment coupling plate for rear mounting	C880031	
Driver area cover	C880049	
Rear weights 180 kg/396 lbs (90kg/198lbs+90kg/198 lbs)	C880054	
4 wheel spacer 10 mm (0.4 in) (max. 1 pcs for wheel)	C880090	
Flat face coupling kit	C880221	
Plexiglass windscreen (smart cabin)	C883000	
Fully enclosed cab with sound insulation linen and mirrors	C883001	
Heating system	C883002	
High comfort heated seat	C883006	
Automatic locking plate	C883008	
Warning & Safety lights for road travel (with mirrors)	C883010	
Floating boom valve	C883011	
Rear hydraulic outlets - single	C883015	
Rear hydraulic outlets - double	C883016	
3 additional working LED light	C883018	
Left protection bar for operator	C883020	
Backup warning beeper	C883021	
Rear 12V electric socket	C883023	
Additional front hydraulic outlets	C883026	
Biodegradable oil	C883032	
Plexiglass right side (smart cabin)	C883034	
Plexiglass back window (smart cabin)	C883035	
Rear bull bar with side extensions	C883037	
Beacon light	C883039	
3 additional working halogen light	C883064	
Cab with A/C, heating system, sound insulation linen and mirrors	C883902	
Tractor tires 26x12.00-12 ET-50, set of 4	C884009	
Grass tires 26x12.00-12 ET-50, set of 4	C884010	
Skid tires 27x8.50-15, set of 4	C884011	

9.6 FEATURES AND OPTIONS

Options		Code	Price
Skid tires 27x10.50-15, set of 4		C884012	
Grass tires 400/50-15, set of 4		C884013	
Wheel spacer 55 mm (2.2 in), set of 4		C885010	
Trailer coupling		C885017	
Rear weights (440 kg / 970 lbs)		C885025	
220 V engine block heater		C885250	
110 V engine block heater		C885255	
Snow chains for wheel		see page 60	

Machine packages		Code	Price
9.6	ALL SEASON: Fully enclosed cab with sound insulation linen and mirrors + Heating system + Floating boom valve + Work light kit + Engine Block Heater	C965005/AS	
	COMFORT: High comfort heated seat + 3 additional wor- king led lights + Floating boom valve	C965005/C	