

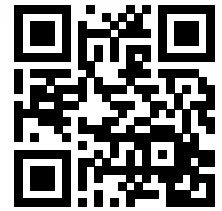





10.8

<http://tiny.cc/10seriesEN>

 TIPPING LOAD 2700 kg	 ENGINE POWER 72 hp	 SPEED 32/40 km/h	 FLOW RATE 95 l/min	 LIFT HEIGHT 3,21 m
--	---	--	--	--

Model	10.8
Engine	Yanmar 4TNV98
Power (Iso Gross)	72 HP
Fuel	Diesel
Transmission	Hydrostatic
Drive speed (max.) - 2 speed	16 - 32 km/h (10 - 20 mph) 20 - 40 km/h (12.4 - 24.8 mph)
Aux. hydraulics oil flow	95 l/min (25 GPM)
Max. lifting height	3,21 m (126.4 in)
Tipping load, max ⁽¹⁾	2700 kg (5952 lbs)
Lifting capacity straight ⁽²⁾	2160 kg (4762 lbs)
Lifting capacity fully articulated ⁽³⁾	1700 kg (3748 lbs)
Breakout force / 50 cm	2600 kg (5732 lbs)
Pushing force (c)	2650 kgf (2650 kp)
Specific ground pressure (w/standard tires)	892 kg/m ² (183 lbs/sqft)
Turning radius: inside/outside	1030/2550 mm (40.5/100.4 in)
Standard tires (Tractor profile)	31X15.50-15 (400/50-15)
Weight	2140 kg (4718 lbs)
Product Code	C966000
Price	

Features

- Hi-Flow system
- 4WD hydrostatic Direct Drive motors, proportional servo control
- DBS (Dynamic Block System)
- Torque divider
- Engine power control
- Self-levelling double-H telescopic boom
- 11-functions joystick
- Multi-disk parking brake
- Radial Piston high efficiency and heavy duty wheel motors
- 2 Speed
- Hydraulic oil cooler
- Hydraulic multiconnector
- ROPS-FOPS Level I
- LCD graphic display with programmed service (tachometer, hour meter, fuel gauge, maintenance light, light indicator and other 14 indicators)
- 2 front working light
- Ergonomic full adjustable suspension seat with armrests and safety belt.

⁽¹⁾ Maximum load that can be lifted just off the ground when the machine is straight, with back-weights and boom not extended. Weight of attachment included.

⁽²⁾ Machine straight, with back-weights and boom not extended. Weight of attachment is included. (80% of tipping load)

⁽³⁾ Machine fully articulated, with back-weights and boom not extended. Weight of attachment is included.

10.8 FEATURES AND OPTIONS

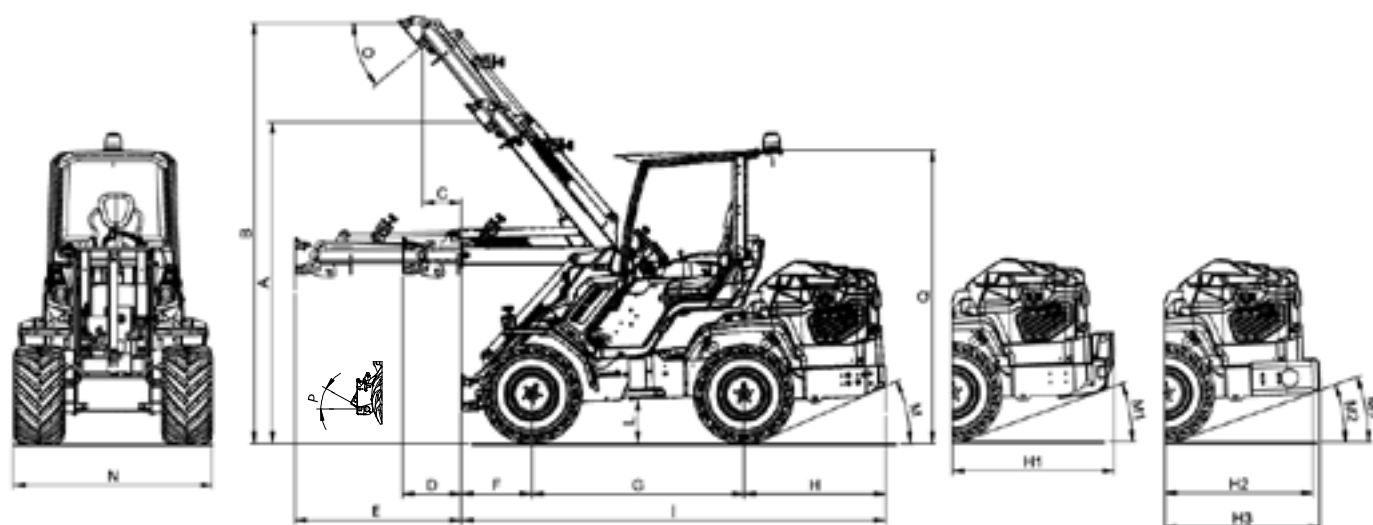

DIMENSIONS (mm / in)

A - Pivot point height (not extended boom)	2530 / 99.6	I - Machine length (without back-weights)	3200 / 126
B - Pivot point height (extended boom)	3210 / 126.4	L - Ground clearance	340 / 13.4
C - Outreach with lifted boom (extended boom)	460 / 18	M - Angle of departure (without back-weights)	24°
D - Outreach with orizontal boom (not extended)	460 / 18	M1 - Angle of departure (with 440 kg back-weights)	19°
E - Outreach with orizontal boom (extended)	1256 / 49.5	M2 - Angle of departure (with 180 kg back-weights - side)	21°
F - Front length	530 / 20.8	M3 - Angle of departure (with 180 kg back-weights - rear)	21°
G - Wheelbase	1600 / 63	N - Max width (with standard tires)	1500 / 59
H - Rear length (without back-weights)	1070 / 42	O - Dump angle	31°
H1 - Rear length (with 440 kg back-weights)	1225 / 48.2	P - Rollback angle	29°
H2 - Rear length (with 180 kg back-weights - side)	1115 / 43.9	Q - Height (with standard tires)	2150 / 84.6
H3 - Rear length (with 180 kg back-weights - rear)	1170 / 46	Q1 - Height with A/C (with standard tires)	2350 / 92.5

Tires size	Width (N)	Height (Q)
31X15.50-15	1500 mm (59 in)	2150 mm (84.6 in)
27X10.50-15	1370 mm (54 in)	2100 mm (83 in)
27X8.50-15	1320 mm (52 in)	2100 mm (83 in)
26X12.00-12	1410 mm (55.5 in)	2090 mm (82.5 in)

10.8 FEATURES AND OPTIONS

Options	Code	Price
Attachment coupling plate for rear mounting	C880031	
Driver area cover	C880049	
Additional back-weights 180 kg/396 lbs (90kg/198lbs+90kg/198 lbs)	C880054	
Wheel spacer 10 mm (0.4 in) (max. 1 pcs for wheel)	C880090	
Multiconnector to quick coupling 3 lines adapter	C880221	
Plexiglass windscreen (smart cabin)	C883000	
Fully glass cab with inner clothing	C883001	
Heating system	C883002	
High comfort heated seat	C883006	
Automatic locking plate	C883008	
LED Road lights "Hella" with mirrors	C883010	
Floating boom valve	C883011	
Rear hydraulic outlets - single	C883015	
Rear hydraulic outlets - double	C883016	
3 additional working LED light "Hella"	C883018	
Left protection bar for operator	C883020	
Backup warning beeper	C883021	
Rear 12V electric socket	C883023	
Additional front hydraulic outlets	C883026	
Biodegradable oil	C883032	
Plexiglass right side (smart cabin)	C883034	
Plexiglass back window (smart cabin)	C883035	
Rear bull bar with side extensions	C883037	
Beacon light	C883039	
Cab with A/C, heating system and inner clothing	C883100	
Tractor tires 26x12.00-12 ET-50, set of 4	C884009	
Grass tires 26x12.00-12 ET-50, set of 4	C884010	
Skid tires 27x8.50-15, set of 4	C884011	
Skid tires 27x10.50-15, set of 4	C884012	

10.8 FEATURES AND OPTIONS

Options		Code	Price
Grass tires 400/50-15, set of 4		C884013	
Wheel spacer 55 mm (2.2 in), set of 4		C885010	
Trailer coupling		C885017	
Additional back-weights (440 kg / 970 lbs)		C885025	
220 V engine block heater		C885250	
110 V engine block heater		C885255	
Snow chains for wheel		see page 64	

Machine packages		Code	Price
10.8	ALL SEASON: Cab with A/C, heating system and inner clothing + Floating boom valve	C966000/AS	
	COMFORT: High comfort heated seat + 3 additional working LED lights + Floating boom valve	C966000/C	