

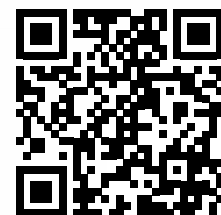





1.1

<http://tiny.cc/multione1-1EN>

 TIPPING LOAD 320 kg	 ENGINE POWER 12 hp	 SPEED 8 km/h	 FLOW RATE 19 l/min	 LIFT HEIGHT 1,8 m
---	---	--	--	---

Model	1.1
Engine	Yanmar L100
Power (Iso Gross)	12 HP
Fuel	Diesel
Transmission	Hydrostatic
Drive speed (max.)	8 km/h (5 mph)
Aux. hydraulics oil flow	19 l/min (5 GPM)
Max. lifting height	1,8 m (70.9 in)
Tipping load, max ⁽¹⁾	320 kg (705 lbs)
Lifting capacity ⁽²⁾	250 kg (551 lbs)
Breakout force / 50 cm (19.7 in)	250 kg (551 lbs)
Pushing force (c)	500 kgf (500 kp)
Specific ground pressure (w/standard tires)	390 kg/m ² (80 lbs/sqft)
Turning radius: inside/outside	0/993 mm (0/39 in)
Standard tires (Tractor profile)	18x9.50-8
Weight	390 kg (860 lbs)
Product Code	C926005
Price	

⁽¹⁾ Maximum load that can be lifted just off the ground when the machine is straight. Weight of attachment included.

⁽²⁾ Weight of attachment is included (80% of tipping load).

1.1 FEATURES AND OPTIONS

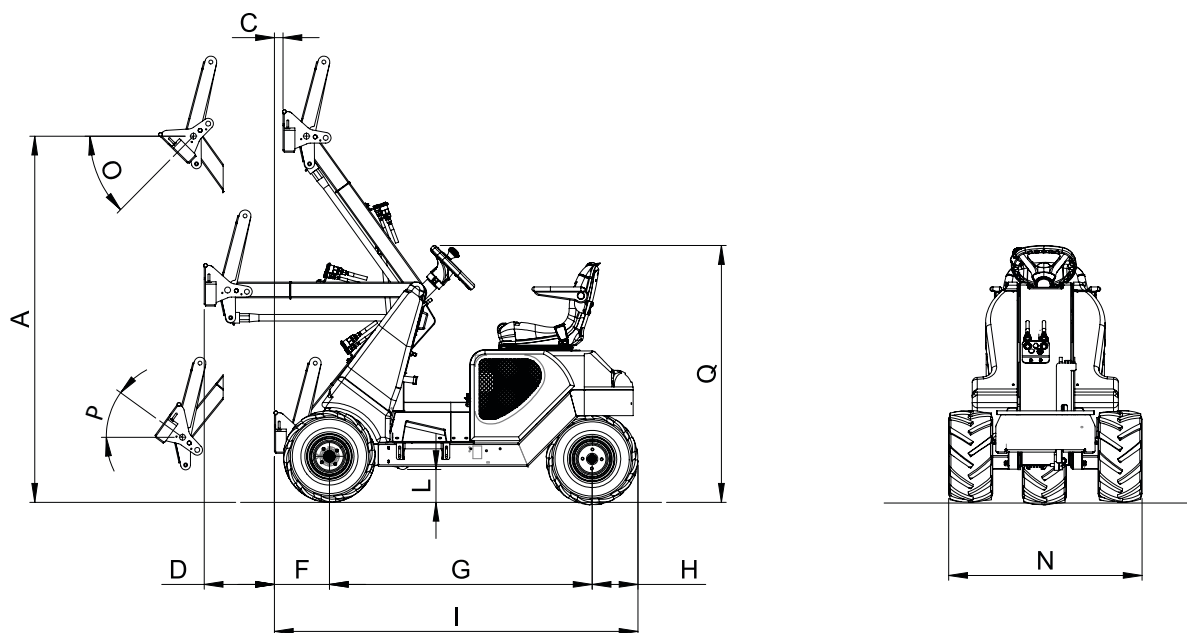

DIMENSIONS (mm / in)

A - Pivot point height	1877 / 73.9	I - Machine length	1864 / 73.4
C - Outreach with lifted boom	44 / 1.7	L - Ground clearance	168 / 6.6
D - Outreach with orizontal boom	360 / 14.2	N - Max width (with standard tires)	992 / 39
F - Front length	282 / 11.1	O - Dump angle	45,5°
G - Wheelbase	1347 / 53	P - Rollback angle	35,5°
H - Rear length	235 / 9.2	Q - Height (with standard tires)	1316 / 51.8

Features

- 3WD hydrostatic transmission with differential lock
- 3 line hydraulic outlets
- Boom with self-levelling
- 4-functions joystick
- Ergonomic seat with adjustable position
- Mechanical parking brake

Options	Code	Price
Biodegradable oil	C883059	
Grass tires 18x9.50-8, set of 3	C885023	